

Shakespeare
Composite Structures

NEW PRODUCT

THE WINNER for sports lighting

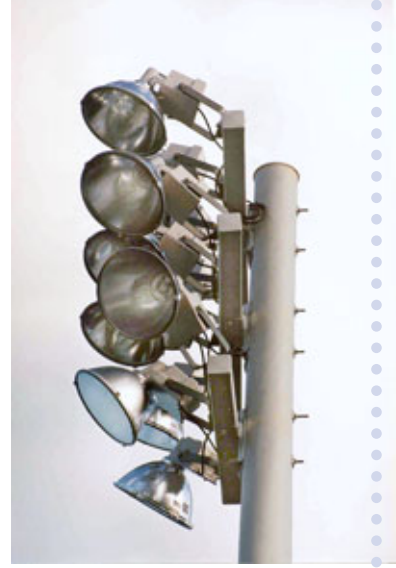

Tall and strong, composite SportsLighting Tuff-Poles® support the heaviest loads without even working up a sweat.

- Great looking poles in your choice of colors, built for sports lighting duty
- Easy, fast installation with minimal heavy equipment needed
- Environmentally safe fiberglass composite construction will never rot, rust, or corrode
- Veil finish has UV inhibitors formulated in for extremely long life, and strength retention over a very long useful life.
- Climbing steps available
- Mounting heights up to 70 feet
- Luminaire assemblies up to 1,000 pounds
- Poles will not twist, rotate, or warp over time - no re-aiming luminaires, no puddles of darkness
- Non-conductive - eliminates potential hazards
- Insect and woodpecker proof
- Heavy duty Composite Cross Arms available in 2' to 10' lengths to create the lighting arrays you need
- Tuff-Pole® reliability, durability, and strength.

Shakespeare's composite SportsLighting Poles are easily installed, great looking, and extra strong to support large luminaire assemblies.

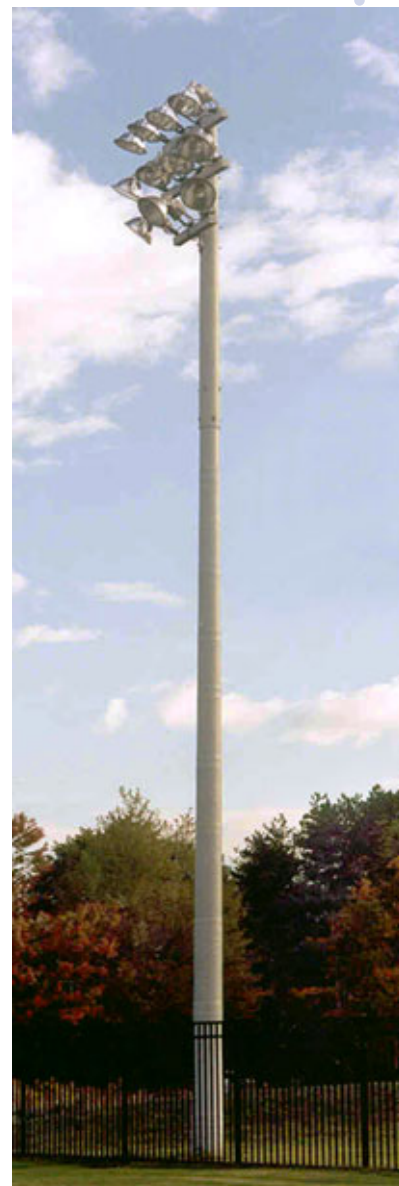

Shakespeare SportsLighting Direct Burial Poles

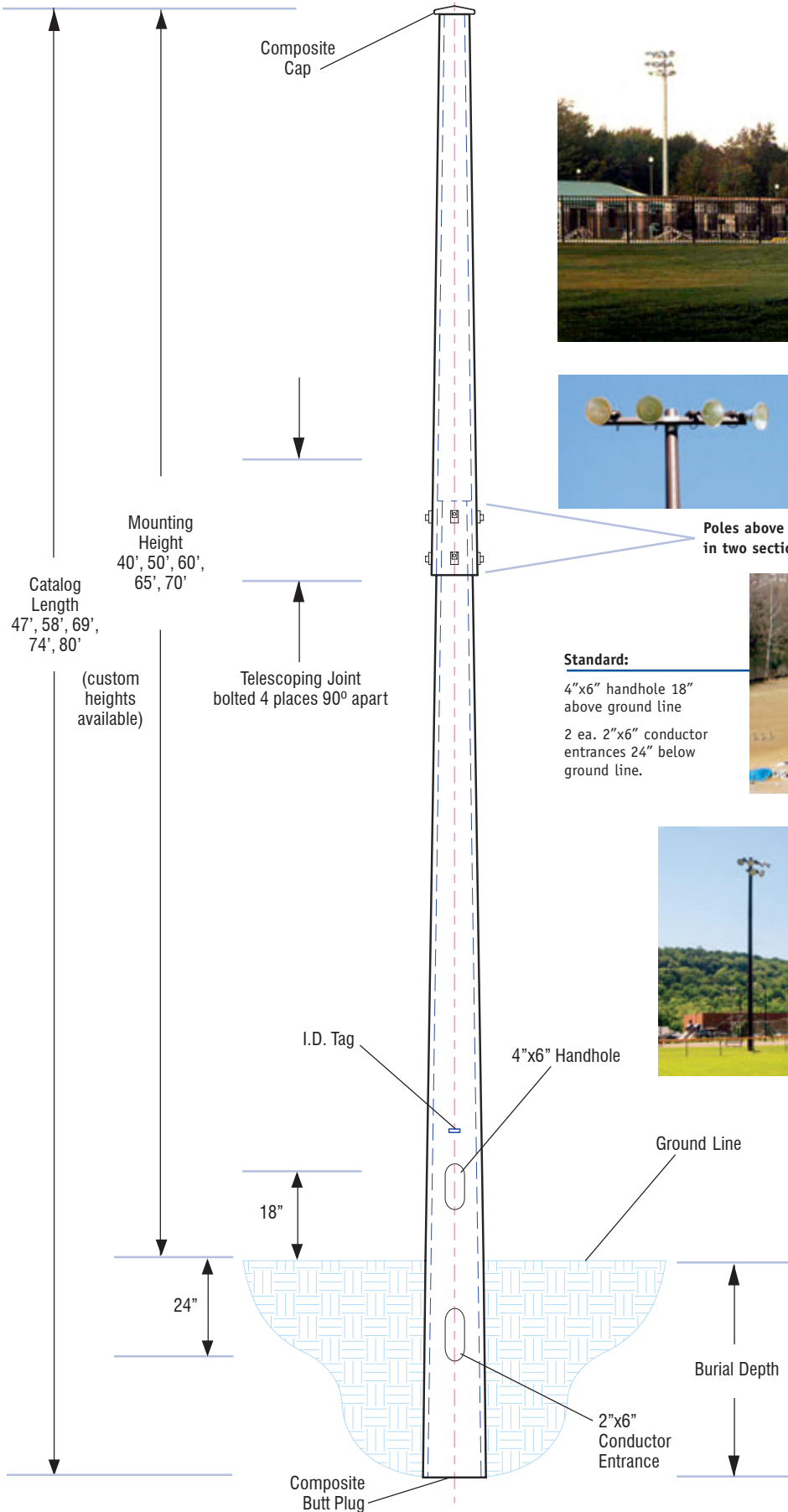

Poles above 40' Mounting Height are supplied in two sections, to be joined on site as shown.

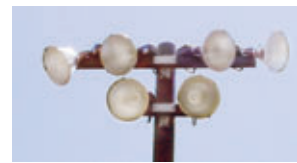

How to order

Shakespeare Composite Structures™ SportsLighting Tuff-Poles® are designed for big, tough jobs, and they can take it standing up. They look great, and with Shakespeare's superior Tuff-Pole® process and engineering they keep on doing their job over the long haul.

To order, specify series, catalog length, and options according to the order logic panel. The example is for SLX69-1X5S, a 69-foot X Series bronze Tuff-Pole® with one cross arm and optional steps. Specify SportsLighting Cross Arms according to their separate logic panel.



SportsLighting Poles

Series:
S=Standard Duty
H=Heavy Duty
X=Extra Heavy Duty

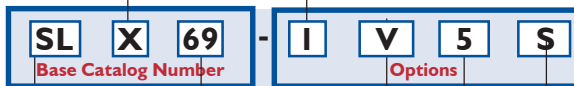

Sports Lighting Pole

Catalog length (not mounting height) in ft.
40' MH = 47
50' MH = 58
60' MH = 69
65' MH = 74
70' MH = 80 (S or H)
Custom heights available

X Series not available in 80' length

Shaft lengths shown are based on standard burial depths; confirm with site engineer.

Cross Arms
1, 2, 3 or 4

Veil Finish

Color
2=Gray
5=Bronze

Optional Steps
S=Yes

Optional Steps begin 8' from the ground line and stop 4' from the top, spaced 18" apart.

SportsLighting Cross Arms

Cross Arms Catalog Number OPXA - **Length (in ft.)** I - 2

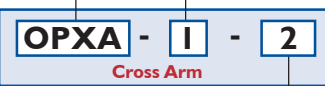

Color
2=Gray
5=Bronze

SportsLighting Cross Arms come with wiring access holes to keep the wiring inside the arm. Luminaires are field installed unless otherwise specified. Arm attachment hardware is included.

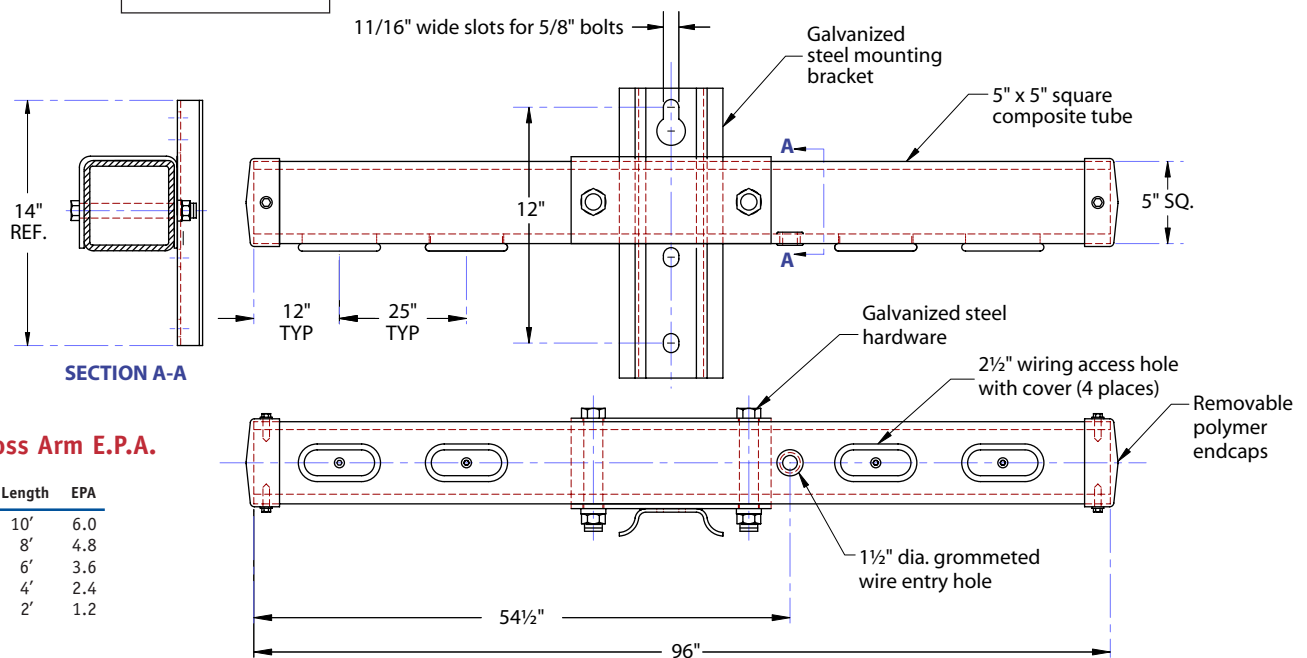

Cross Arm E.P.A.

Length	EPA
10'	6.0
8'	4.8
6'	3.6
4'	2.4
2'	1.2

SportsLighting Poles E.P.A. Ratings

In square feet, including a 30% Gust Factor, per A.A.S.H.T.O standards.

	80 MPH	90 MPH	100 MPH	120 MPH
STANDARD	23.4	18.5	15.0	10.4
HEAVY	39.1	30.9	25.0	17.4
EXTRA HEAVY	54.7	43.2	35.0	24.3





Shakespeare Composite Structures™

19845 Highway 76 • Newberry, SC 29108

803.276.5504 • F/803.276.8940 • Toll-free in U.S.A.: 1.800.800.9008 • www.skp-cs.com

A Division of Genlyte Thomas Group, LLC